

Research Article

Analysis of Perturb & Observe MPPT Algorithm for PV System Interfaced with Boost Converter under changing Climatic conditions

Shyam Manohar Gupta^Å and Anmol Ratna Saxena^{Å*}^ÅDept. of Electrical Engineering, Madhav Institute of Technology and Science Gwalior, Madhya Pradesh, India

Accepted 10 June 2014, Available online 30 June 2014, Vol.4, No.3 (June 2014)

Abstract

The solar PV modules exhibit non-linear I-V characteristics and its maximum power point varies throughout the day with varying climatic conditions. The PV modules have low power conversion efficiency and hence maximum power available at any given period of time must be tracked to have full utilization of the PV module capacity. In this paper, dc-dc Boost converter is used to interface PV module with load and to match source and load characteristics to operate PV module at maximum power point. Maximum power point tracking (MPPT) techniques are used to track the maximum power point under varying climatic conditions. Perturb & observe (P&O) MPPT algorithm is used in this paper for tracking of maximum power point (MPP). The mathematical model of the PV cell is developed and transformed in Matlab Simulink environment for analysis and design. Performance of the algorithm is analyzed for varying solar insolation and loading condition for which simulations are carried out in MATLAB/Simulink environment and validated through experimental results. Simulation and experimental results are in close correlation with each other.

Keywords: Photovoltaic (PV) array; dc-dc boost converter; Maximum Power Point Tracking (MPPT); Perturb & Observe (P&O) method.

1. Introduction

Photovoltaic (PV) energy system is an established technology and had recently experienced rapid growth over the last many years. Sunlight is present almost everywhere on the earth and so PV systems are worldwide acceptable. It is more significant due to storage and environmental impacts of conventional fuels because the sunlight is non-exhaustible and pollution free fuel for PV system. Generally PV panels are used in solar energy system and photovoltaic cell is the key component which converts the solar energy into electrical energy by photovoltaic effect. But these PV cells have low conversion efficiency which depends on the weather conditions. Also the installation cost of the system is significantly high, so it is necessary to increase the efficiency of PV system (Tariq and Asghar, 2005; Al-Bahadili, *et al*, 2013).

However, the solar photovoltaic arrays have nonlinear output characteristics and are continuously affected by the changing environment factors. So it is necessary to maintain the maximum power point at all instant of time, for this, the maximum power point tracking (MPPT) algorithms are used along with the dc-dc converters, which works as an intermediate circuit and locate between PV array and load (Yuan and Xingxing, 2010). Dc-Dc boost converters are used when the boosting of the source voltage is required (Saxena, 2010). In this paper, the

Perturb & observe MPPT algorithm is implemented with the boost converter to extract and maintain maximum power from the solar panel. The algorithm has been analyzed for different irradiation levels and it is shown that the MPPT tracks the maximum power point for changing insolation levels. The Boost converter adjusts its impedance value according to fix load by the changing of duty ratio in order to match the load side impedance with the panel's internal impedance for delivering the maximum power at the given insolation level. Moreover this paper studies about the performance of the system also depends on the load provided to the converter. This study reveals that the boost converter can operate as a MPPT in a specific load range. When any value of the load within that range provides to the converter, than it is able to extract maximum power from the solar panel at given irradiations and maintains the MPP.

2. PV Generator Models

The PV generator is the combination of many PV cells connected in series and parallel fashion to provide the desired output voltage and current. This PV generator exhibits nonlinear insolation dependent V-I characteristics. The solar cell has low output voltage (about 0.5-0.7V), so solar cells have to be connected in series and parallel combination according to the requirements of voltage and power ratings and in practical applications (Walker, 2001), (Ting-Chung and Tang-Shiuan, 2009; Veerachary, *et al* 2002). The single diode model (Fig.1), is the simplest

*Corresponding author: Anmol Ratna Saxena

equivalent circuit of PV cell, a current source in parallel with a diode.

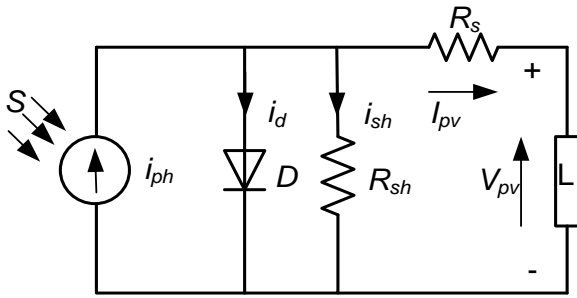

Fig.1 The equivalent circuit of Solar cell

The accuracy of the model can be increased by adding following parameters, however this increases the complexity (Walker, 2001):

- Temperature dependence of the diode saturation current I_d .
- Temperature dependence of photo current I_{ph} .
- Series resistance R_s , which gives a more accurate shape between the maximum power point and the open circuit voltage. This represents the internal losses due to the current flow.
- Shunt resistance R_{sh} , in parallel with the diode, this corresponds to the leakage current to the ground and it is commonly neglected.
- Either allowing the diode quality factor A to become a variable parameter (instead of being fixed at either 1 or 2) or introducing two parallel diodes with independently set saturation currents.

On applying Kirchoff's current law in the Fig. 1, the basic solar cell equation is given by (Veerachary, et al, 2002), (Aashoor and Robinson, 2012), (Nedumgatt, et al, 2011), (Altin and Yildirimoglu, 2013)

$$I_{pv} = I_{ph} - I_d - I_{sh} \tag{1}$$

The term I_{ph} is the photocurrent, depends on the operating temperature and the solar irradiation/insolation (S) and is given by eq. (2).

$$I_{ph} = \frac{S}{1000} \left[I_{scr} + \beta (T - T_{ref}) \right] \tag{2}$$

Here, I_{scr} is the short circuit current at reference temperature of $25^\circ C$ and solar radiation (S) of $1kW/m^2$, β is the temperature coefficient of cell, T and T_{ref} is the cell operating and reference temperature respectively in Kelvin (K). I_d the diode internal diffusion current which is defined by eq. (3)

$$I_d = I_o \left[\exp \left(\frac{q(V_{pv} + I_{pv} \cdot R_s)}{A \cdot K \cdot T} \right) - 1 \right] \tag{3}$$

q is the charge of electron ($=1.61 \cdot 10^{-19} C$), A is the diode ideality factor (or completion factor), K ($=1.38 \cdot 10^{-23} J/K$) is Boltzmann's constant and T is the PV cell's operating temperature (or absolute temperature) in Kelvin (K).

The I_o in the equation represents the dark saturation current or diode saturation current (or the holding current

in opposite direction), which is always be present and produces when there is no light. I_o is thermally generated, and changing the temperature affected on the generated current because of its temperature dependency as follows

$$I_o = I_{rs} \left(\frac{T}{T_{ref}} \right)^3 \exp \left[\frac{q \cdot E_g}{A \cdot K} \left(\frac{1}{T_{ref}} - \frac{1}{T} \right) \right] \tag{4}$$

I_{rs} is the cell reverse saturation current in ampere (A) at T_{ref} and solar irradiation (S). E_g is the band-gap energy of semiconductor. Finally the equivalent of an ideal relationship between the output current and voltage can be written as in Eq.5.

$$I = I_{ph} - I_o \left[\exp \left(\frac{q(V_{pv} + I_{pv} \cdot R_s)}{A \cdot K \cdot T} \right) - 1 \right] - \frac{V_{pv} + I_{pv} \cdot R_s}{R_{sh}} \tag{5}$$

The above equation is valid for the single diode model. Where R_s is the equivalent series resistance and R_{sh} is the equivalent shunt resistor of PV cell. Usually, the value of R_s is small & the value of R_{sh} is very large, so under ideal conditions, these quantities are negligible. Eq. (5) is transformed into Matlab/Simulink model for analysis and design. The simulated $I-V$ and $P-V$ characteristics at different solar irradiation levels at a fixed temperature of $25^\circ C$ are plotted and shown in Fig. 2.

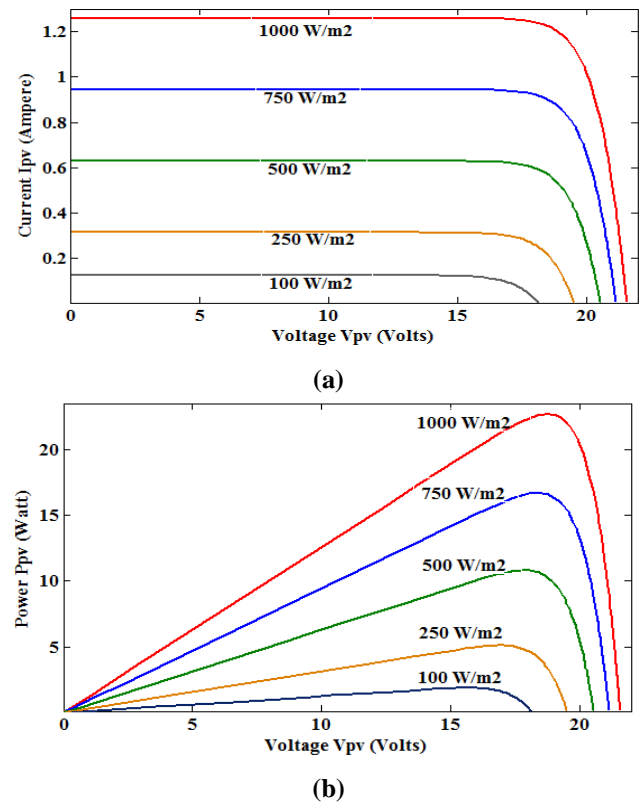

Fig.2 Simulated characteristics of solar panel at different insolation (a) V-I characteristics (b) P-V characteristics

3. Maximum Power Point Tracking with Boost Converter

The basic function of any switch-mode dc-dc converter, in any PV system as an intermediate power processor is that it changes the current and voltage levels such that

maximum power can be extracted from the PV arrays (Veerachary, 2008). Changing voltage and current levels is nothing but converting a given fixed load to a variable load. The connected load may be of stand-alone sink type, battery, up-stream converters or combination of these (Veerachary, 2009), (Saxena, 2012).

The block diagram showing implementation of MPPT using dc-dc boost converter is shown in Fig. 3. The analysis of the system is carried out under the following assumptions (Veerachary, 2008):

- 1) Switching elements (MOSFET and Diode) of the converter are assumed to be ideal.
- 2) The equivalent series resistance of the capacitance and stray capacitances are considered.
- 3) Passive components of the converter (R, L, C) are assumed to be linear, time invariant and frequency independent.
- 4) Converter is assumed to be operating in continuous inductor current mode of operation.

The boost converter with the MPPT actually replaces the fix load by an equivalent load according to the effective load requirement of the PV, at which maximum power can be deliver to the load. The relationship between the input and output voltages and currents is derived for boost converter and is given by eq. (6) and (7). While reflected load across the solar panel terminals is obtained and given by eq. (8).

$$V_{in} = V_o(1 - D) \tag{6}$$

$$I_A = \frac{I_{in}}{\eta(1 - D)} \tag{7}$$

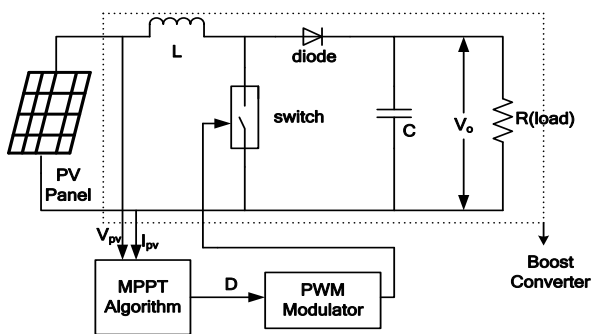

Fig.3 PV Panel along with Boost converter for MPP Tracking

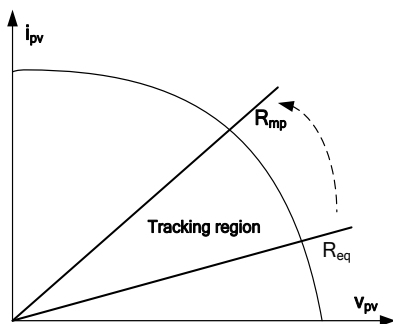

Fig.4 Load region for MPPT operation with Boost converter

$$\frac{V_{in}}{I_{in}} = R_{eq} = \eta R(1 - D)^2 \tag{8}$$

Here, V_{in} and I_{in} are the converter input voltage and current i.e. solar PV output voltage and current, V_o and I_o are the output voltage load current of the converter, D is the duty ratio and η is the efficiency of the converter.

The intersection of current-voltage (I-V) curve and the load line gives the operating point of directly coupled PV module to the load. This point should be at the MPP of the PV module to extract the maximum power. The performance of a DC-DC converter depends on the input impedance and the connected load R_L which are most important parameters for any converter. To get the maximum power from the panel, the fix load side should be replaced by an equivalent value that corresponds to MPP load line. Achieving the true MPPT depends on: (i) the type of switch-mode converter used, (ii) nature of load present on the converter, (iii) status of converter operation etc (Veerachary, 2009), (Farahat, et al, 2012). For the boost converter, the satisfactory condition that fulfill for the MPPT, the connected load on the converter must be greater than corresponding equivalent maximum power load ($R > R_{mp}$) of PV array. If the load greater ($R > R_{mp}$) then it is possible to bring down the load to the operating load (R_{mp}) by using duty ration modulation. If the load is less ($R < R_{mp}$), then there is no method to convert the provided load into R_{mp} . In the ideal conditions duty ration varies in between (0 to 1). The practical range of duty ratio is roughly in the range of (0.1~0.9), hence by the eqn. 8. Calculating the corresponding load should be in the range of (Veerachary, 2008).

$$1.234R_{mp} < R < 100R_{mp} \tag{9}$$

3.1 The Perturb & Observe (P&O) MPPT Algorithm

Perturb and observe (also called as hill climbing) method is most popular and widely adopted strategy amongst all MPPT methods. This method is also preferred for commercial PV panel because it is easy to implement (Houssamo, et al, 2010). The flow chart of basic hill climbing algorithm is shown in Fig. 5(a) (NianCHun, et al, 2011). The movement of operating point in the process of identifying MPP on PV is shown in Fig. 5(b). If the present operating point is to the left of MPP, the power varies against voltage as $dP/dV > 0$ and if it is to the right side as $dP/dV < 0$. If $dP/dV > 0$ along with a small perturbation in operating voltage then that perturbation moved the panel's operating point toward the MPP and the algorithm continue to perturb the PV panel voltage in the same direction. If $dP/dV < 0$ then perturbation in voltage changes in operating point moved the panel away from the MPP. In this situation the algorithm reverses the direction of the perturbation (Vieira, and Mota, 2008).

Theoretically, the algorithm has the advantages of being simple to implement in its basic form and few parameters of measurement. However P&O has some limitations, like oscillations around the MPP in steady state operating and this may cause some power loss. It has also limitation of slow response speed, and confusion in tracking under the rapidly changing atmospheric condition. To reduce the presented limitations a small sampling rate will be useful to use (Houssamo, et al, 2010), (Vieira, and Mota, 2008).

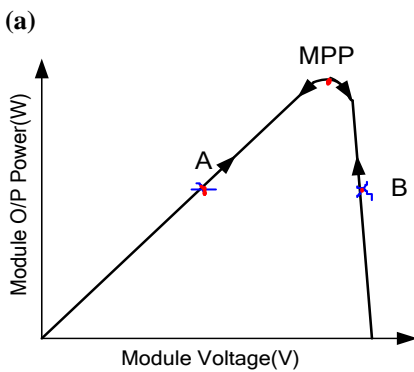
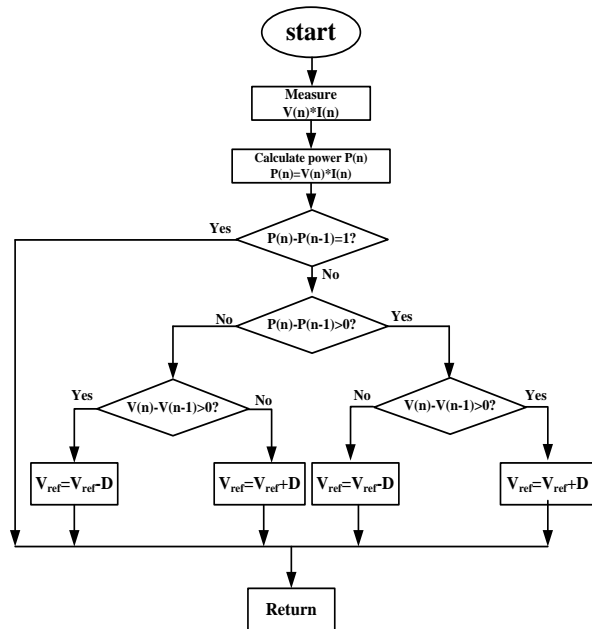

(a) Flow chart, (b) Tracking characteristics

4. Results and Discussion

The simulation studies are carried out using MATLAB (R2009a Version). In-order to verify the theoretical concepts and simulation studies experimental prototype of the system is developed in lab which is shown in Fig. 6. The details of the solar panel used are summarized in Table 1 while that of boost converter are summarized in Table 2.

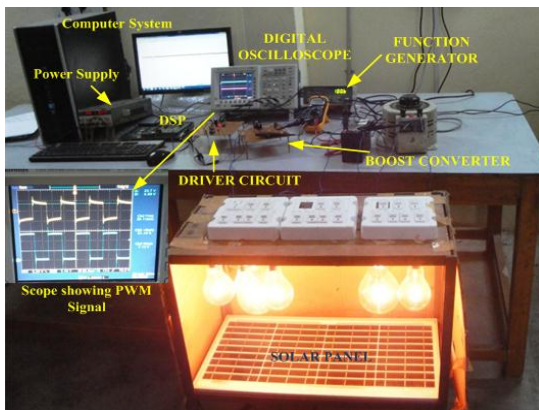

Fig.6 Experimental setup developed in laboratory

Table 1 Parameters of PV module

Parameters	Value
Maximum Power (P_{max})	20W
Voltage at P_{max} (V_{mp})	17.77V
Current at P_{max} (I_{mp})	1.13A
Open circuit Voltage(V_{oc})	22.04V
Short circuit current (I_{sc})	1.26A
Tolerance	$\pm 5\%$

Table 2 Boost Converter Parameters

Parameter	Values
V_{in}	15 V
L	150 μ H
C	220 μ F
f_{sw}	20 kHz
R_{load}	10 Ω

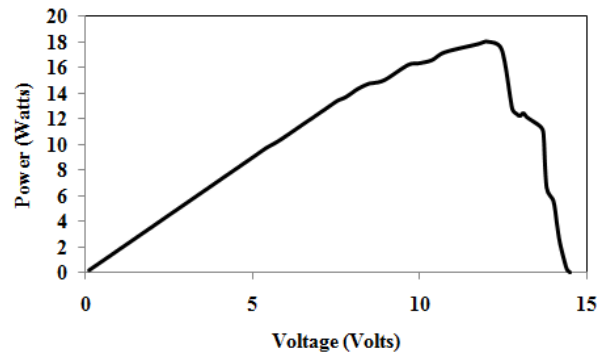
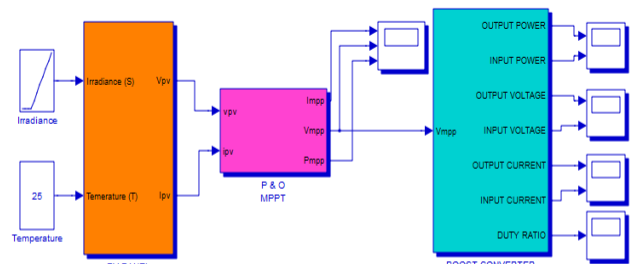
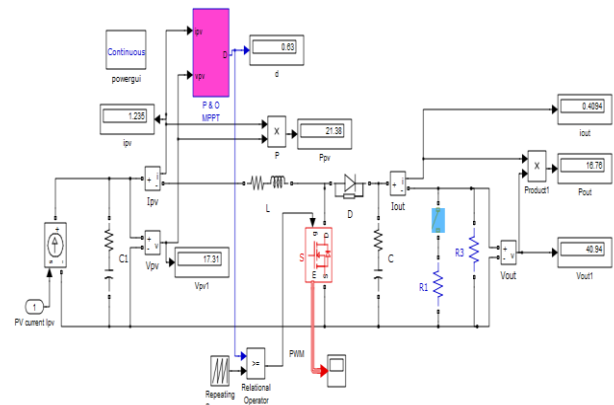

Fig.7 Experimentally measured PV characteristics



(a) Simulink Model



(b) Simpower system model of boost converter

Fig.8 P&O implemented using boost converter for MPPT

Experimentally obtained P-V characteristic of PV panel is shown in Fig. 7. The changing insolation level is given to the PV panel (Fig. 8) which results in the change of the duty ratio to find the new MPP. Simulations time is 0.1 sec and the solar irradiation are changed from $S=750 \text{ W/m}^2$ to 1000 W/m^2 . The duty ratio (D), inductor current (i_{pv}) input-output voltages (V_{pv} & V_o) and powers (P_{pv} & P_o) at their respective insolation level are shown in the Fig. 9. The study state waveforms of average duty ratio and inductor current are given in the inset (zoom in) of their respective results. These studies reveal that the boost converter is capable of tracking maximum power from the PV array for all solar insulations.

Table 3 helps to find the load resistance of the boost converter for tracking the maximum power from the PV panel. Fig. 10 indicates the load lines at respective irradiances level. These load lines are the minimum require value for proper operation of MPPT in respective climate condition. From the table 3, it is clear that at $S=1000 \text{ W/m}^2$ irradiation level the load required for the boost converter is $R_L > 15.32 \Omega$ which is equivalent to standard operating condition and at the $S=100 \text{ W/m}^2$ (lowest climate condition) the load requirement is $R_L > 133.1 \text{ Ohms}$ for the tracking and maintain the MPP.

Table 3 MPPs data at highest and lowest climate conditions

Conditions	P_m (W)	I_{mpp} (A)	V_{mpp} (V)	$R_{opt}(\Omega)$
At 1000 W/m^2 radiations	20.46	1.15	17.62	$R_{opt(min)}=15.32$
At 100 W/m^2 radiations	1.67	0.11	14.64	$R_{opt(max)}=133$
Standard test conditions (1000 W/m^2 , 25°C)	20	1.13	17.77	$R_{opt}=15.72$

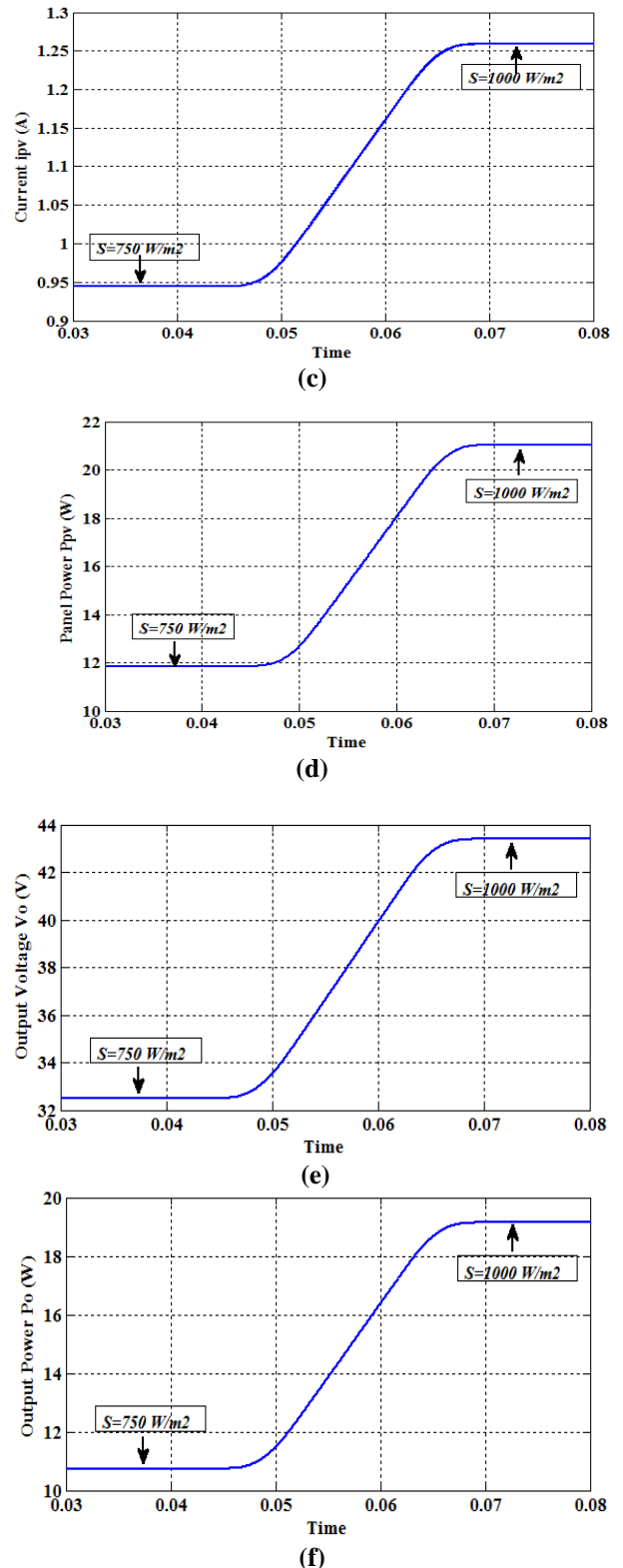
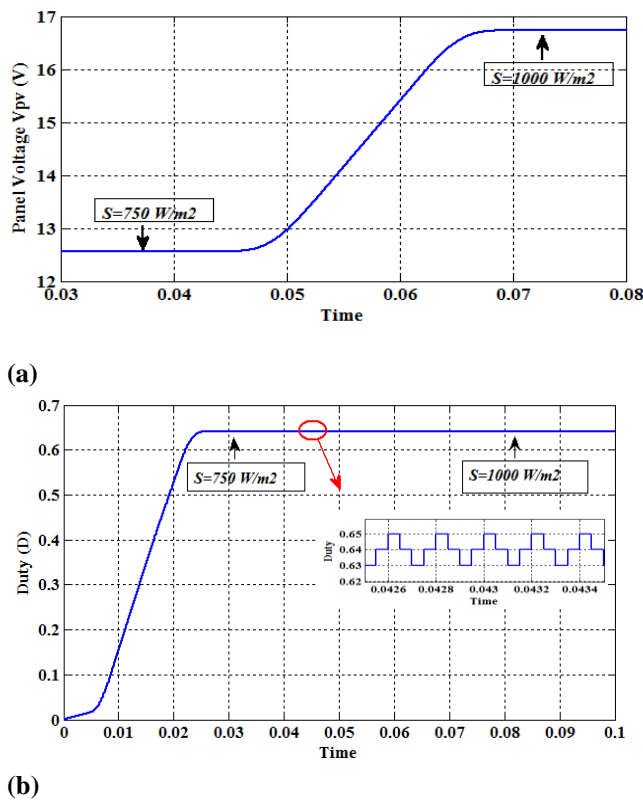

Fig. 9 Input-output characteristics at $S_1=750 \text{ W/m}^2$ to $S_2=1000 \text{ W/m}^2$ for boost converter and P&O controller (a) Panel voltage V_{pv} (b) Duty D (c) Inductor current I_{pv} (d) Input power P_{pv} (e) Output voltage V_o (f) Output power P_o

Fig.11 shows the capability of boost MPPT topology to match the optimum impedance with different resistive loads. When $R_L=140 \text{ Ohms} > R_{opt(max)}$, the converter is capable of tracking the MPP at all. When $R_L=100 \text{ Ohms}$, $R_{opt(min)} < R_L < R_{opt(max)}$, the converter can track the MPP as

far as the PV panel's internal impedance $R_L \leq 100$ Ohms. In short the highest performance of the MPPT based on boost converter under different climate conditions, the load impedance must be close to but larger than $R_{opt(max)}$ e.g. 140 Ohms. In our study the load resistance fixed at 100 ohms for suitable MPPT of the PV panel. The Fig.12 represents the various input and output characteristics on different load impedances

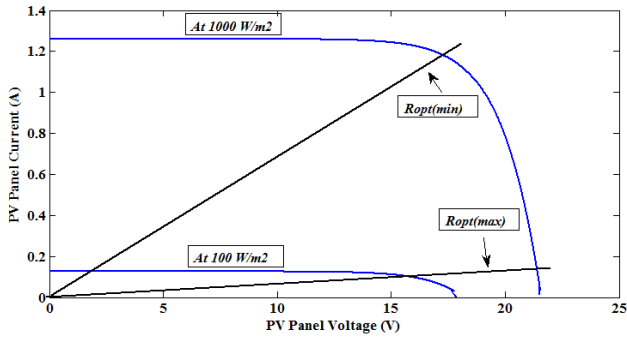

Fig.10 The optimum impedance at the highest and lowest climate conditions

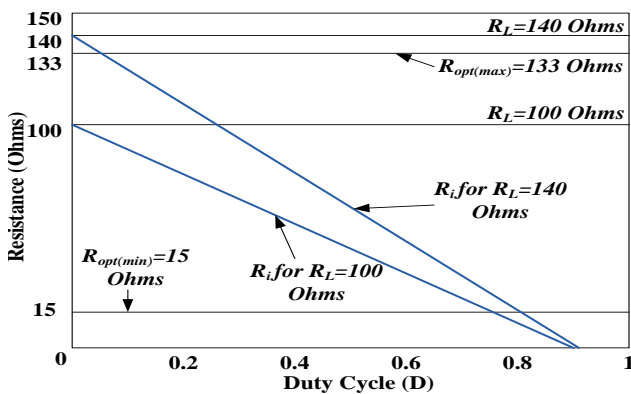
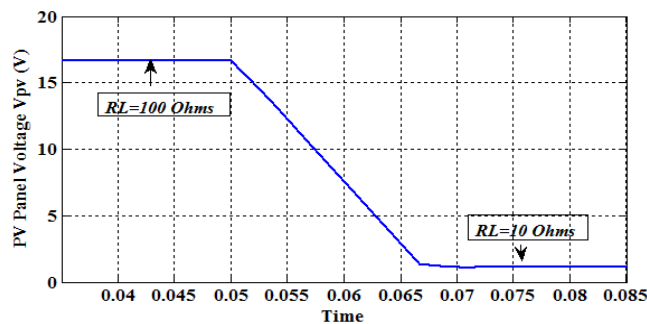
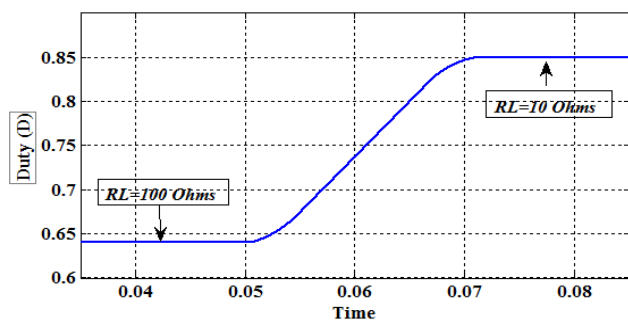

Fig.11 Operation of MPPT based on the boost converter in various load regions



(a)



(b)

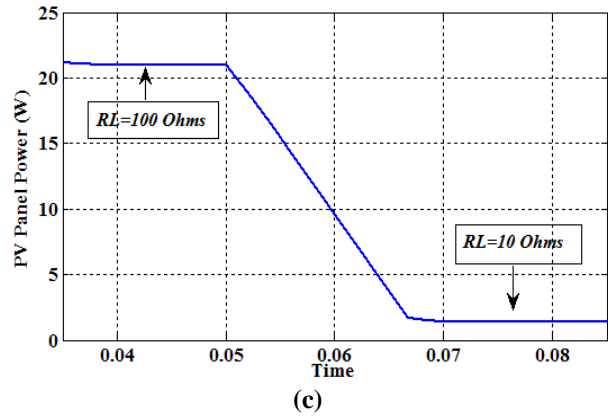

Fig.12 Input-output characteristics at $R_L=100$ Ohms to $R_L=10$ Ohms for boost converter and P&O controller (a) PV Panel Voltage V_{pv} (b) Duty D (C) PV panel Power P_{pv}

Conclusion

This paper studies the effect of changing insolation level on voltage and power of a solar panel. P&O MPPT algorithm had been implemented using the boost DC-DC converter. It was observed from the simulation results that the operating point of the converter also changes with changing irradiation level to find and maintain the new MPP at that insolation level. The maximum and minimum operating values of load were calculated and it was shown that load on converter must be greater than R_{opt} for MPP tracking. The performance of boost converter with MPPT at different loads and under changing climate conditions was studied. By providing a suitable fix operating load within that load range, the boost converter is capable to extract the maximum power from the PV panel at given insolation level.

Acknowledgement

The authors sincerely acknowledge Director, MITS Gwalior, India for his support during this research work.

References

A. Tariq, J. Asghar, (2005), Development of an Analog Maximum Power Point Tracker for Photovoltaic Panel, *PEDES. International Conference on*, vol. 1, no., pp. 251, 255.
 H. Al-Bahadili, H. Al-Saadi, R. Al-Sayed, M.A.-S. Hasan, (2013), Simulation of maximum power point tracking for photovoltaic systems, *Applications of Information Technology to Renewable Energy Processes and Systems (IT-DREPS), 1st International Conference & Exhibition on the*, vol., no., pp. 79,84.
 Lu Yuan, Cui Xingxing, (2010), Study on maximum power point tracking for photovoltaic power generation system, *Computer Science and Information Technology (ICCSIT), 3rd IEEE International Conference on*, vol. 9, pp. 180,183.
 G. Walker, (2001), Evaluating MPPT converter topologies using a MATLAB PV model, *Journal of Electrical & Electronics Engineering, Australia, IEAust*, vol. 21, No. 1, pp. 49-56.
 A. R. Saxena, M. Veerachary, (2010), Robust digital deadbeat control for DC-DC power converter with online parameter estimation, *Proc. Joint Int. Conf. on Power Electron., Drives and Energy Syst. (PEDES) & 2010 Power India*, pp.1-5, Dec. 2010.
 Yu Ting-Chung, Chien Tang-Shiuan, (2009), Analysis and simulation of characteristics and maximum power point tracking for photovoltaic systems, *Power Electronics and*

- Drive Systems, PEDS. International Conference on, pp. 1339,1344.
- M. Veerachary, T. Senjyu, K. Uezato, (2002), Voltage-based maximum power point tracking control of PV system, *Aerospace and Electronic Systems, IEEE Transactions on*, vol. 38, no. 1, pp. 262,270.
- F. A O Aashoor, F. V. P. Robinson, (2012), A variable step size perturb and observe algorithm for photovoltaic maximum power point tracking, *Universities Power Engineering Conference (UPEC), 47th International*, pp. 1,6.
- M. Veerachary and A. R. Saxena, (2012), Design of Robust Digital Stabilizing Controller for Fourth-Order Boost DC-DC Converter: A Quantitative Feedback Theory Approach, *IEEE Trans. on Ind. Electron.*, vol. 59, No. 2, PP. 952-963, Feb. 2012.
- J.J. Nedumgatt, K.B. Jayakrishnan, S. Umashankar, D. Vijayakumar, D.P. Kothari, (2011), Perturb and observe MPPT algorithm for solar PV systems-modeling and simulation, *India Conference (INDICON), Annual IEEE*, pp. 1,6.
- N. Altin, T. Yildirimoglu, (2013), LabVIEW/MATLAB based simulator for grid connected PV system, *Power Engineering, Energy and Electrical Drives (POWERENG), Fourth International Conference on*, pp. 1316,1321.
- M. Veerachary, (2008), Maximum Power Point Tracking Algorithm For Non-Linear DC Sources, *Industrial and Information Systems, ICIIS, IEEE Region 10 and the Third international Conference on*, pp. 1,6.
- M. Veerachary, (2009), Maximum power point tracking parameter selection for higher order converters used in photovoltaic applications, *Power Systems, ICPS, International Conference on*, pp. 1,6.
- M.A. Farahat, H.M.B. Metwally, Ahmed Abd-Elfatah Mohamed, (2012), Optimal choice and design of different topologies of DC-DC converter used in PV system, at different climate conditions in Egypt, *Renewable Energy*, Vol., no., 43, pp. 393,402, .
- Issam Houssamo, Fabrice Locment, Manuela Sechilariu, (2010), Maximum power tracking for photovoltaic power system: Development and experimental comparison of two algorithms, *Renewable Energy*, Vol., no., 35, pp. 2381,2387.
- Wang NianCHun, Wu MeiYue, Shi GuoSheng, (2011), Study on Characteristics of Photovoltaic Cells Based on MATLAB Simulation, *Power and Energy Engineering Conference (APPEEC), Asia-Pacific*, pp. 1,4.
- J.A.B. Vieira, A.M. Mota, (2008), Maximum power point tracker applied in batteries charging with PV panels, *Industrial Electronics, ISIE, IEEE International Symposium on*, pp. 202,207.
- A. R. Saxena, M. Veerachary, (2010), Robust digital deadbeat control for DC-DC power converter with online parameter estimation, *Proc. Joint Int. Conf. on Power Electron., Drives and Energy Syst. (PEDES) & 2010 Power India*, pp.1-5, Dec. 2010.